

HRS H.FL SERIES

The world's smallest low-profile coaxial connectors H.FL Coaxial Connectors

■ OUTLINE

The H.FL series of coaxial connectors consists of the world's smallest surface-mount low profile coaxial connectors.

The H.FL connectors have a lower profile, with a mounted height of approximately 30% that of our S.FL2 connectors. They occupy 20% less board space, allowing higher density internal wiring.

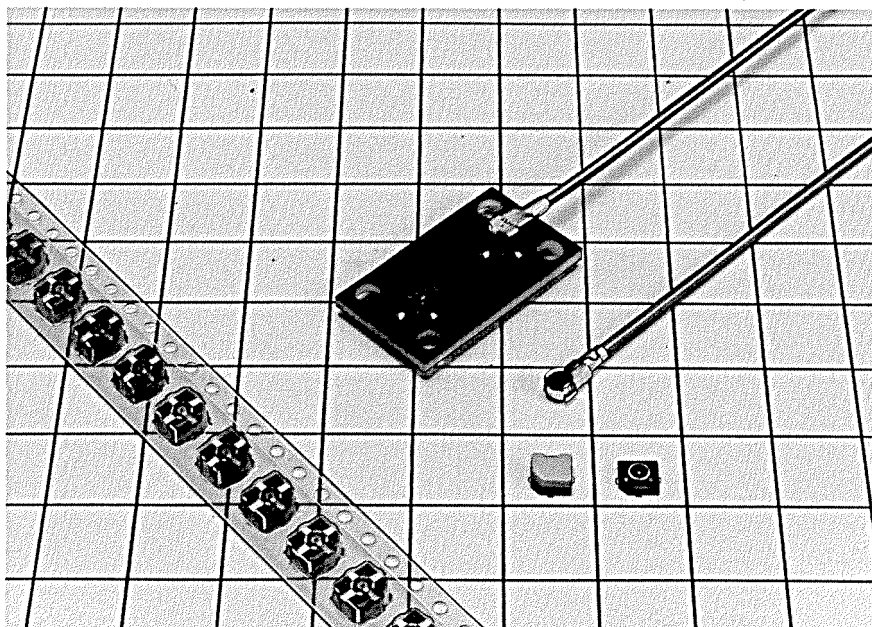

■ FEATURES

- (1) Height off printed circuit board of 3mm when connected (lowest in the world).
- (2) High frequency response of V.S.W.R 1.3 or less from D.C., A.C.1 to 3000 MHz.
- (3) Compressed wire system used on the cable side connector for both the center and exterior, providing stable connection quality. For the external conductor compression part, the shielded wire is compressed between metal, providing stability with respect to fluctuations in heat.
- (4) Wiring is possible with ultra-thin teflon cables with an external diameter of $\phi 1.48$, making high density internal wiring possible.
Compatible with the Junkosha DFS111-UL1979, the Hitachi CO-6F and FH-SB cables, as well as other cables in the future.
- (5) The connector can be easily removed with an extraction jig.
- (6) Emboss taping makes automatic mounting possible. In addition, connectors with caps are available for use with all types of mounters.
- (7) Connection can be easily verified. Despite the ultra small size, a locking feeling is provided making it possible to check that the connector is securely connected.
- (8) The connectors are equipped with an scoop-proof mechanism protecting against mis-insertion.
- (9) A cut is provided on the circuit board side connector, making it simple to check the direction after mounting.

■ APPLICATIONS

Portable telephones, cellular telephones, wireless communications devices, electronic measuring equipment, GPS, etc.

■ MATERIALS and TREATMENT

| Part name | Material | Treatment |
|-----------------------|---|----------------|
| Shell | Phosphor bronze | Silver plating |
| Insulator | PBT plastic (plug side) Liquid crystal polymer (receptacle side) | Black Black |
| Male center contact | Bronze | Gold plating |
| Female center contact | Phosphor bronze | Gold plating |

■ PERFORMANCE

| Item | Rated value |
|-----------------------------|---|
| Characteristic impedance | 50 Ω |
| Insulation resistance | 500MΩ or greater at DC 250V |
| Contact resistance | 20mΩ (center), 10mΩ (exterior) at DC 10mA |
| Dielectric strength | AC 300V (r.m.s), 1 minute |
| Contact service life | 50 times |
| Voltage standing wave ratio | 1.3 or less, DC to 3000MHz (target value) |

■ PRODUCT INFORMATION

▲ L-shaped plugs

| Item | HRS No. | Model No. | Sales Quantities | Applicable cable | A Dimension | B Dimension |
|------------------------|-----------------|----------------------------|--|---|-------------|-------------|
| Right-angle plug shell | CL331-0503-4-01 | H.FL-LP-DFS111(01) | Sold by the package (100 pieces per pack) | Hitachi CO-6F and FH-SB Junkosha DFS111-UL1979 Sumitomo 0.8DS-PBE | 10.4 | (6.95) |
| | CL331-0504-7-01 | H.FL-LP-A32 (01) | Sold by the package (100 pieces per pack) | Junkosha A(2BO733) | 10.8 | (7.35) |
| | CL331-0506-2 | H.FL-LP-1.25S(01) | Sold by the package (100 pieces per pack) | Hitachi 1-25C-6FFH | 10.4 | (6.95) |
| Female contact | CL331-0511-2 | H.FL-LP Female contacts | Sold by the reel (10,000 contacts per reel) | Common cable is Used as above | | |

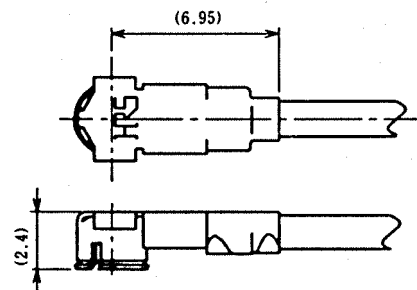
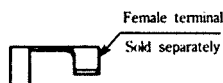
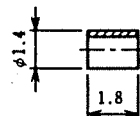
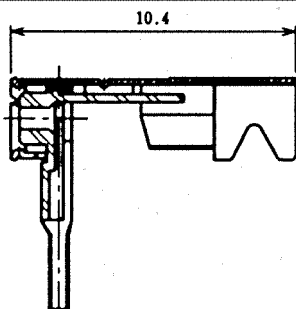
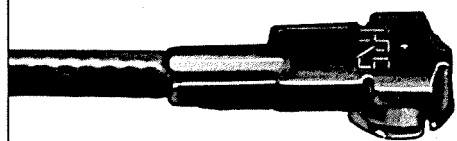

View after connected to cable

Note 1 : Sales quantities of the H.FL-LP-DFS111(01) H.FL-LP-A32(01) are in units of 1 package (containing 100 pieces).
Also note that the H.FL-LP female contacts are sold in units of 1 reel (containing 10,000 pieces).

Note 2 : The female contacts are sold as separate items.

▲ Receptacles

| HRS No. | Model No. | Sales Quantities |
|-----------------|-----------------|---|
| CL331-0521-6-01 | H.FL-R-SMT (01) | Sold by the package (100 pieces per pack) |
| CL331-0521-6-10 | H.FL-R-SMT (10) | Sold by the reel (2,500 pieces per reel) |

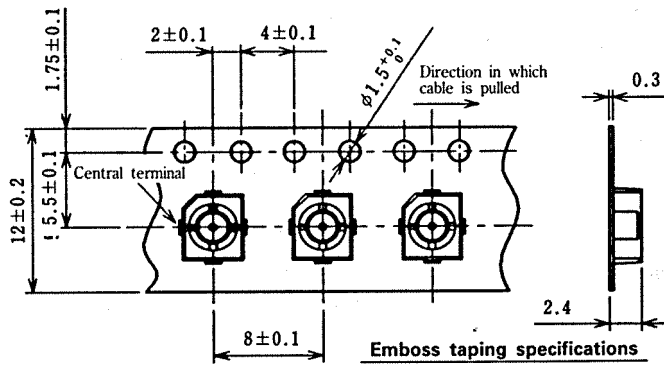
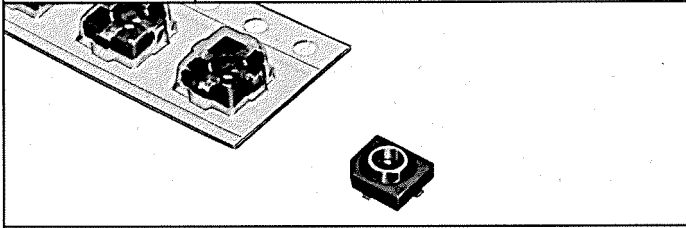

- Note 1:** Sales quantities of the H.FL-R-SMT(01) are in units of 1 package (containing 100 pieces). Also note that the H.FL-R-SMT(10) are sold in units of 1 reel (containing 2,500 pieces).
- Note 2:** These products may not be mountable with certain mounters.
- Note 3:** Allowable mold plastic on central terminal.

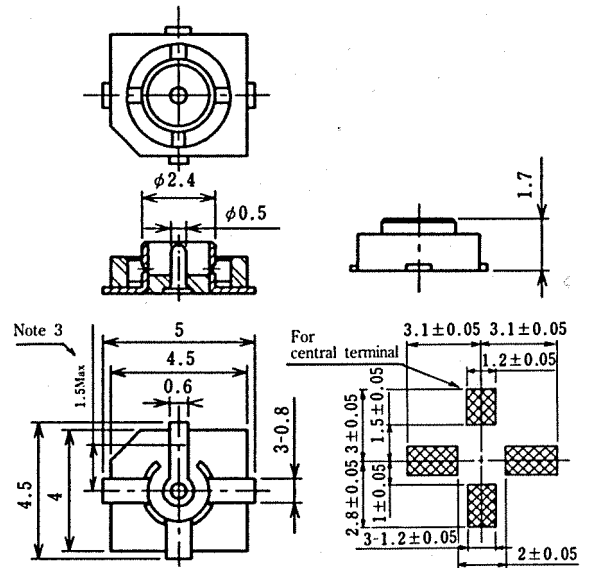

Recommended circuit pad

▲ Receptacles (with caps)

| HRS No. | Model No. |
|-----------------|---------------------|
| CL331-0522-9-10 | H.FL-R-SMT (C) (10) |

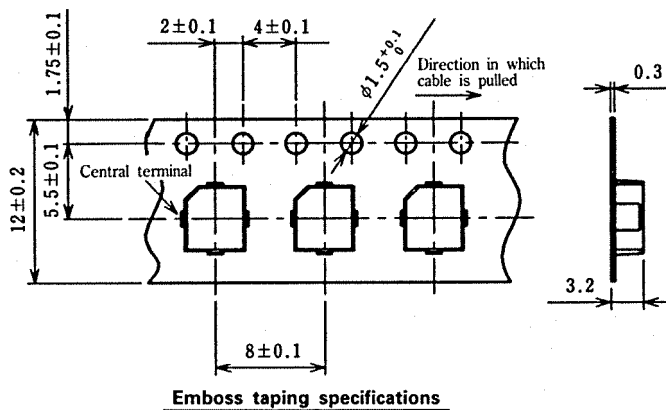
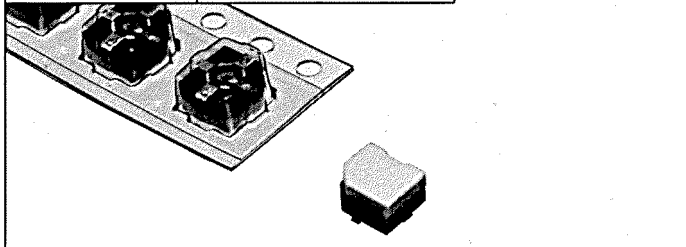

- Note 1:** These receptacles are sold in minimum units of 1 reel (2500 receptacles).
- Note 2:** These products include caps so that they can be mounted with any mounters. They cannot be inserted as such. Remove the cap after reflow.
- Note 3:** Allowable mold plastic on central terminal.

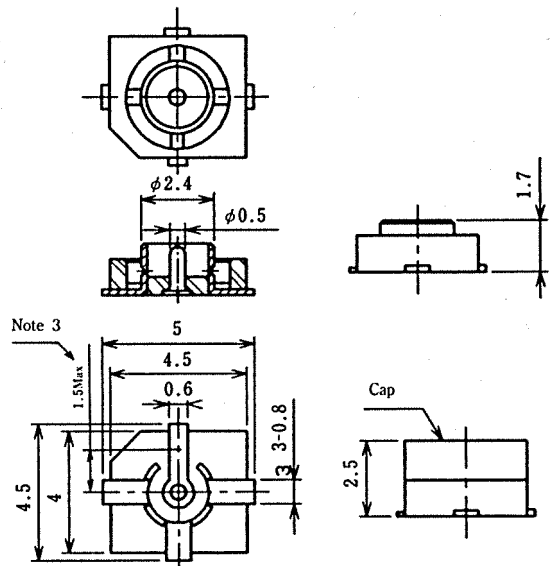

Final product diagram

▲ Converter Adapters

| HRS. No. | Part Number |
|--------------|-------------|
| CL311-0232-4 | HRMP-H.FLJ |

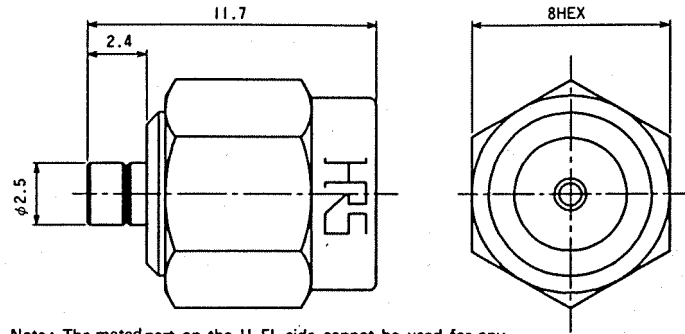
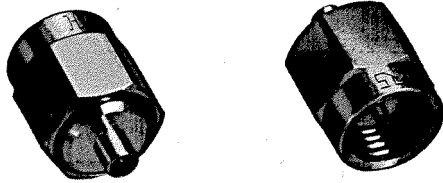

Note: The mated part on the H.FL side cannot be used for any purpose other than performance measurement because there is no lock mechanism.

| HRS. No. | Part Number |
|--------------|--------------|
| CL311-0264-0 | HRMJ-H.FLP-3 |

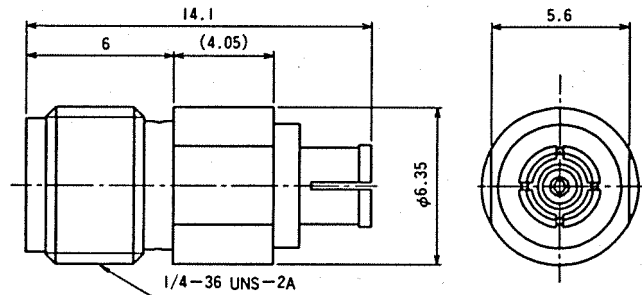
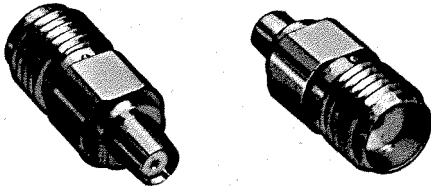

Note: The mated part on the H.FL side cannot be used for any purpose other than performance measurement because there is no lock mechanism.

▲ Attachments

| HRS. No. | Part Number |
|--------------|-------------|
| CL331-0516-6 | H.FL-R-1 |

For Inspection

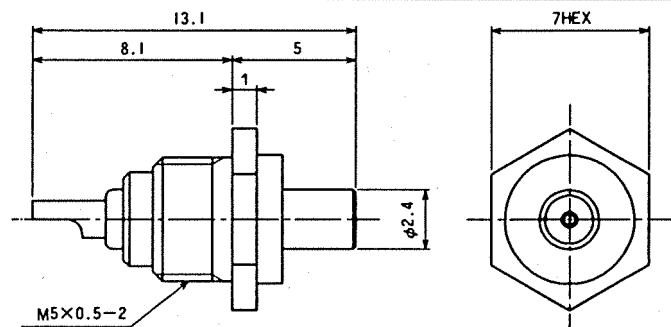
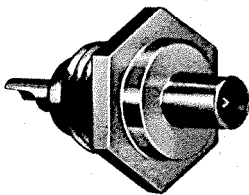

Note: This receptacle is used to inspect the conductivity and withstand voltage of harnesses.

| HRS. No. | Part Number |
|--------------|-------------|
| CL331-0151-9 | S.FL-LP-N |

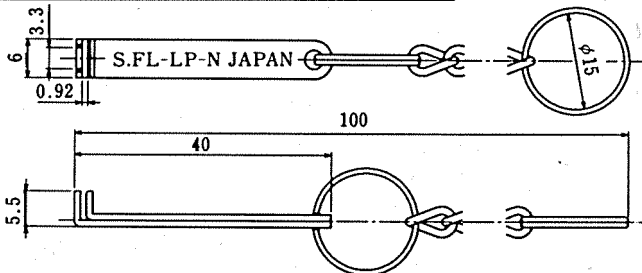

Note: This jig is to withdraw from the coupled state (commonly used for S.FL, S.FL2, and H.FL).

| HRS. No. | Part Number |
|--------------|-------------|
| CL331-0551-7 | H.FL-LP-N |

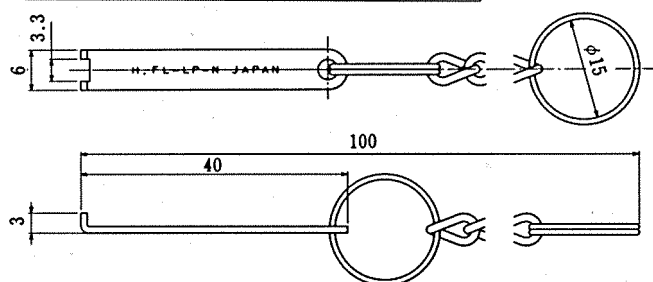

Note: This jig can be used in narrow spaces because it can be inserted from the cable side.

HARNESSED MODELS

For harnessed H.FL series, follow the dimensions specified below.

Single-connector harness

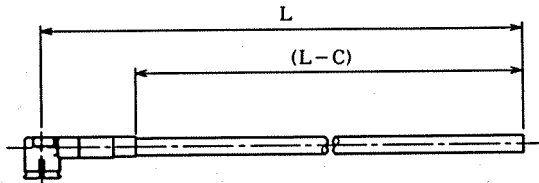

Double-connector harness

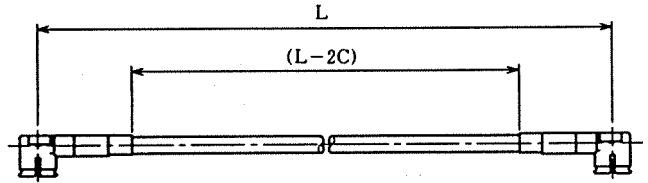

Specify the dimensions from the center of connectors for both single- and double-connector harnesses. Standard dimensional tolerances are as follows:

| Overall length | Tolerance |
|----------------|-----------|
| 35 ~ 200 | ±4 |
| 201 ~ 500 | ±8 |
| 501 ~ 1000 | ±12 |
| 1001 ~ | ±1.5% |

Note: Minimum length: 35 mm

C Dimensions

H.FL-LP-DFS111 : 6.95

H.FL-LP-A32 : 7.35

PRECAUTIONS FOR HANDLING

▲ Plug

● Connector insertion and extraction

- Hook the tip of the S.FL-LP-N or H.FL-LP-N on the lid, and insert/extract the connector vertically along the connector mating axis. Be sure to hold the connector body when inserting/extracting the connector. Never hold the cable when extracting the cable because it damages the connector.
- Insert the connector as perpendicularly to the

mating surface as possible by aligning the mating axes of both connectors. Do not excessively slant the connectors when inserting.

● Allowable loads on the cable after the connectors are mated.

The figures below show the maximum allowable loads on the cable. Do not apply loads exceeding these values to the cable.

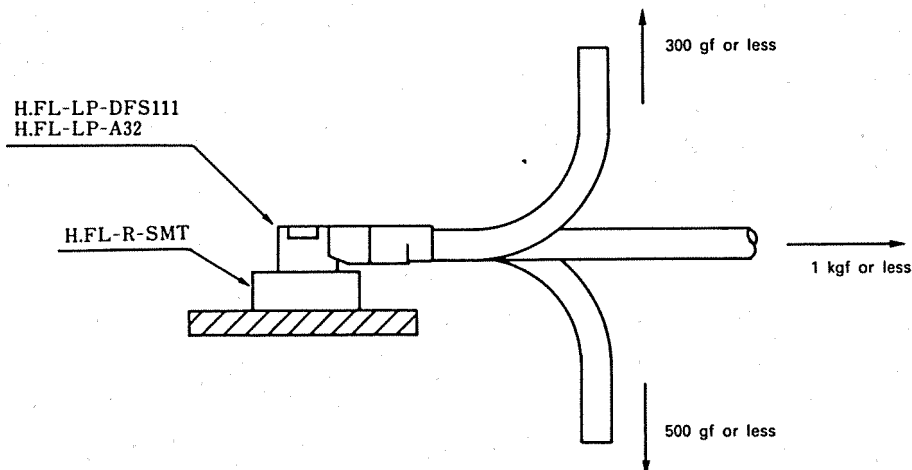

▲ Receptacle

• Dimensions of the land in boards

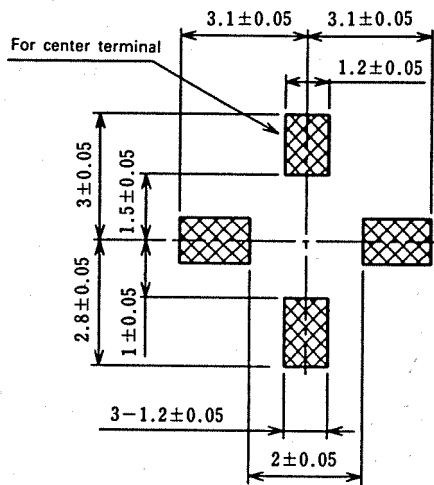

- For land dimensions, strictly follow the values given in the Figure on the left. Otherwise, flux and solder wicking could occur.
- A screen thickness of 0.15 to 0.25 mm is recommended for solder paste printing.

• Packaging temperature profile (reference)

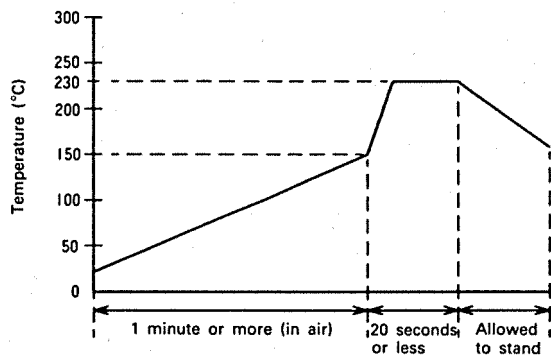

(Note) Complete reflow soldering within 5 seconds at the board surface peak temperature of 240°C or less. The packaging temperature profile varies depending on the board size, type of solder used, and solder thickness.

◆ View of mounted connector

